

FORTAL SOLUTIONS FOR SECURE HEIGHT-ACCESS

PRICE LIST 2023

Ladders with safety cages
Options and accessories

Applicable from July 1st, 2022
and until further notice*

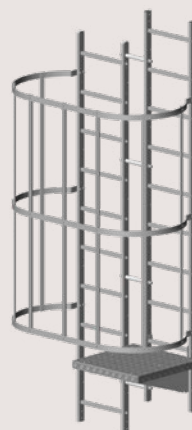

For any quote
request:
crinoline@fortal.fr

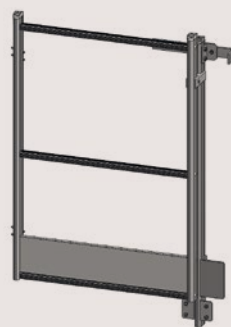
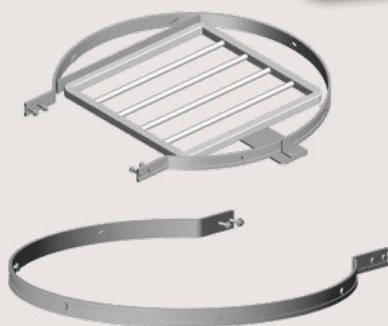

*Depending on the fluctuation of the price of raw materials, this price list can be modified without notice



FORTAL[®]
www.fortal.fr

🇫🇷 Made in France

Ladders with safety cages

NEO range



Ladders

Reference	Product designation	Landmark	Weight kg	Price €
F600101400	Ladder 1400 mm		2.68	52.60
F600102800	Ladder 2800 mm	1	5.36	105.20
F600104200	Ladder 4200 mm		8.03	157.80
F600105600	Ladder 5600 mm		10.71	201.40
F600100045	Wide exit (2 rungs)	2	3.75	85.60
F600100535	Extended wide exit (7 rungs)	3	6.50	165.80
F600100033	Connection for ladder, per piece	4	0.22	12.60
F600100044	Straight exit NEO (2 rungs)		2.61	72.80



Change-over

Reference	Product designation	Landmark	Weight kg	Price €
F600100028	Complete change-over	5	35.50	1015.00

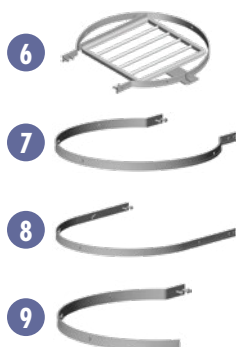

Hoops

Reference	Product designation	Landmark	Weight kg	Price €
F600100009	Standard hoop + security gate	6	3.27	163.00
F600100010	Standard hoop	7	1.49	41.00
F600100012	Complete hoop for wide exit	8	1.44	37.70
F600100013	Complete hoop for lateral exit	9	1.02	31.90

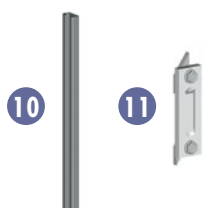

Vertical bars and connection

Reference	Product designation	Landmark	Weight kg	Price €
A859352000	Vertical bar length 2000 mm		0.58	10.60
A859353000	Vertical bar length 3000 mm	10	0.86	15.90
A859356000	Vertical bar length 6000 mm		1.73	31.80
F600200008	Vertical bars connection - per piece (provide 5 pieces for a full connection)	11	0.13	6.90



Plates and wall brackets

Reference	Product designation	Landmark	Weight kg	Price €
F600200123	Wall bracket length 75 mm, per piece	12	0.31	10.20
F600200125	Straight wall bracket length 200 mm, per piece	13	0.34	9.50
F600200120	Wall bracket length 200 mm, per piece	14	0.39	10.70
F600200121	Adjustable wall bracket from 150 to 300 mm, per piece	15	0.56	15.40
F600200020	Adaptable wall fixation (to re-cut) 300 to 544 mm, per piece		1.67	75.00
F600200021	Adaptable wall fixation (to re-cut) 544 to 824 mm, per piece		2.21	78.20
F600200005	Ground angle fixation, per piece	16	0.20	9.30
F600200115	Cladding fixation kit	17	1.00	45.20
F600200003	Adjustable foot, per piece	18	1.00	17.10

Ladders with safety cages

NEO range

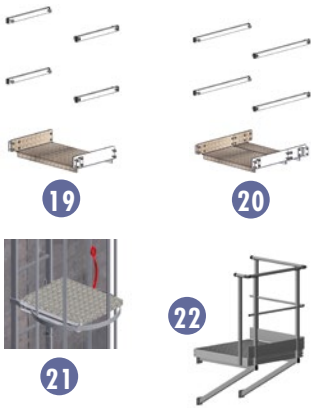

Steps, ladderhead platform and parapet ladderhead platform

Reference	Product designation	Landmark	Weight kg	Price €
F600650200	Ladderhead platform step 200 mm	19	4.05	169.90
F600650200-DIP	Specific ladderhead platform step 200 mm		4.65	216.80
F600650400	Ladderhead platform step 400 mm		7.04	217.90
F600650600	Complete parapet ladderhead platform step 600 mm	20	10.89	271.60
F600650800	Complete parapet ladderhead platform step 800 mm		13.87	322.60
F600651000	Complete parapet ladderhead platform step 1000 mm		18.99	533.20
F600651200	Complete parapet ladderhead platform step 1200 mm		23.79	634.50
F600100089	Retractable platform	21	4.75	174.90
F600200450	Lateral access platform 1000 x 1000 mm	22	42.07	1191.60
F600200451	Lateral access platform 1500 x 1000 mm		51.14	1432.10
F030800006	Adjustable foot fixation for access platform		0.86	61.50



Gates

Reference	Product designation	Landmark	Weight kg	Price €
F600100041	Gate for wide exit and for ladderhead platform (provide 2 additional vertical bars)	23	3.76	116.50
F600200199	Vertical bars to be fixed on parapet ladderhead platform exit	24	1.43	27.10
F600200400	Width adjustable gate - raw aluminum handrail		5.00	276.10
F600200401	Width adjustable gate - red lacquered handrail		5.00	276.10
F600200411	Width adjustable gate - yellow lacquered handrail		5.00	276.10
F600200402	Lateral exit gate, right/left - Mounting on slab or landing	25	5.90	196.00
F600200405	Lateral exit gate, right/left - Ladder fixing	25bis	4.46	196.00
F600200105	Locking for gate		0.16	18,40

Aluminum retractable poles

Reference	Product designation	Landmark	Weight kg	Price €
F600100017	Retractable pole - fixed on rungs 25 x 25 mm	26	1.28	112.50
F600100018	Retractable pole - fixed on wall	27	1.10	112.50
F600100019	Retractable pole - fixed on profile	28	1.25	112.50
A750016525	Grey foot pad for 65 x 25 mm profile	29	0.05	2.40



Lower access security doors - Aluminum range

Reference	Product designation	Landmark	Weight kg	Price €
F600700005	Door + right or left hinges	30	9.80	445.30
F600700010	Door + cap + right or left hinges	31	12.70	515.10
F600700015	Half door + cap + right or left hinges	32	5.50	375.70
A600000016	Brass padlock 40 mm - steel shackle 22 mm			12.50

Lower access security doors - Steel range

Reference	Product designation	Landmark	Weight kg	Price €
F600500215	Half door + cap		25.00	195.00
F600500220	Door + cap		50.00	360.00

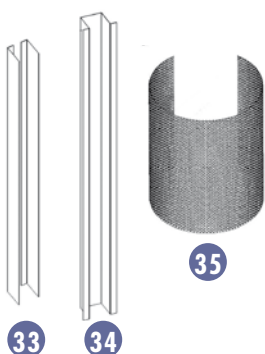

Anti intrusion add-on accessories - Galvanized steel

Reference	Product designation	Landmark	Price €
F600503001	Lateral sheet - height 3000 mm, per pair	33	268.00
F600503003	Bottom panel - height 3000 mm	34	371.00
F600503005	Perforated sheet - height 1000 mm	35	357.00

Ladders with safety cages

Reinforced profile 115 x 25 mm

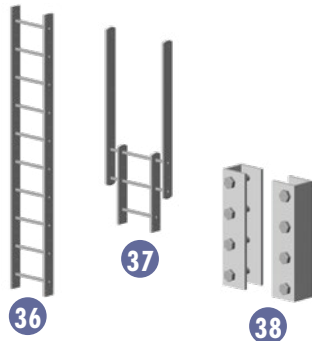

Ladders

Reference	Product designation	Landmark	Weight kg	Price €
F600401400	Ladder 1400 *		6.50	163.90
F600402800	Ladder 2800 *	36	12.90	223.10
F600400045	Wide exit	37	10.40	208.50
F600400016	Complete junction for ladder, per piece (forcast two junctions for a ladder)	38	0.60	24.20

*Step 280 mm - Useful width 400 mm

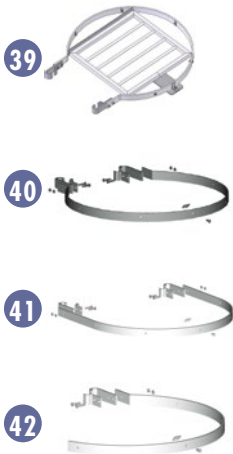

Hoops

Reference	Product designation	Landmark	Weight kg	Price €
F600100009	Standard hoop + security gate	39	3.80	163.00
F600100010	Standard hoop	40	2.00	41.00
F600100012	Complete hoop for wide exit	41	2.00	37.70
F600100013	Complete hoop for lateral exit	42	1.40	31.90

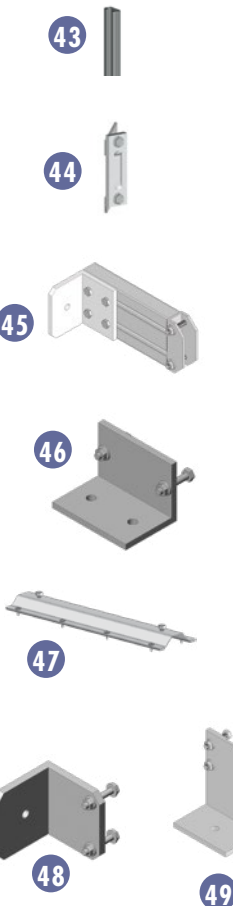

Vertical bars

Reference	Product designation	Landmark	Weight kg	Price €
A859352000	Vertical bar length 2000	43	0.81	10.60
A859353000	Vertical bar length 3000	43	1.221	15.90

Vertical bars connection

Reference	Product designation	Landmark	Weight kg	Price €
F600200008	Vertical bars connection - per piece (provide 5 pieces for a connection)	44	0.13	6.90

Plates and wall brackets

Reference	Product designation	Landmark	Weight kg	Price €
F600400015	Wall bracket L = 200 mm, per piece	45	0.90	42.30
F600400005	Attached angle on floor, per piece	46	0.40	20.40
F600200115	Cladding fixing kit	47	1.00	45.20
F600400012	Wall bracket L = 75 mm, per piece	48	0.52	33.50
F600400014	Wall fixing 400 mm (to re-cut), per piece	-	1.28	51.50
F600400003	Adjustable foot, per piece	49	0.65	26.40

Ladders with safety cages

Reinforced profile 115 x 25 mm

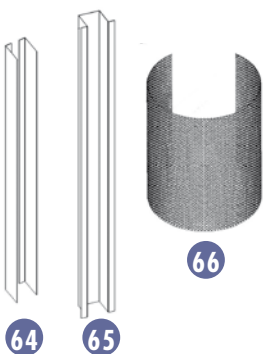
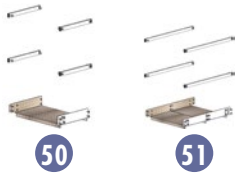

Steps, ladderhead platform and parapet ladderhead platform

Reference	Product designation	Landmark	Weight kg	Price €
F600650200	Ladderhead platform step 200 mm	50	4.05	169.90
F600650200-DIP	Specific ladderhead platform step 200 mm		4.65	216.80
F600650400	Ladderhead platform step 400 mm	51	7.04	217.90
F600650600	Complete parapet ladderhead platform step 600 mm	52	10.89	271.60
F600650800	Complete parapet ladderhead platform step 800 mm		13.87	322.60
F600651000	Complete parapet ladderhead platform step 1000 mm	53	18.99	533.20
F600651200	Complete parapet ladderhead platform step 1200 mm		23.79	634.50
F600100089	Retractable platform	54	4.75	174.90
F600200450	Lateral access platform 1000 x 1000 mm	55	42.07	1191.60
F600200451	Lateral access platform 1500 x 1000 mm		51.14	1432.10
F030800006	Adjustable foot fixation for access platform		0.86	61.50

Gates

Reference	Product designation	Landmark	Weight kg	Price €
F600100041	Gate for wide exit and for ladderhead platform (provide 2 additional vertical bars)	56	3.76	116.50
F600200199	Vertical bars to be fixed on parapet ladderhead platform exit	57	1.43	27.10
F600200400	Width adjustable gate - raw aluminum handrail		5.00	276.10
F600200401	Width adjustable gate - red lacquered handrail		5.00	276.10
F600200411	Width adjustable gate - yellow lacquered handrail		5.00	276.10
F600200402	Lateral exit gate, right/left - Mounting on slab or landing	58	5.90	196.00
F600200405	Lateral exit gate, right/left - Ladder fixing	58bis	4.46	196.00
F600200105	Locking for gate		0.16	18.40

Retractable pole and foot pads

Reference	Product designation	Landmark	Weight kg	Price €
F600100017	Aluminum retractable pole - fixed on rungs 25 x 25 mm	59	1.28	112.50
F600100018	Retractable pole fixed on wall	60	1.10	112.50
A750011525	Foot pad 115 x 25 mm, per piece		0.10	10.90

Lower access security doors - Aluminum range

Reference	Product designation	Landmark	Weight kg	Price €
F600700005*	Door + right or left hinges	61	9.80	445.30
F600700010*	Door + cap + right or left hinges	62	12.70	515.10
F600700015*	Half door + cap + right or left hinges	63	5.50	375.70
F600700001	Fixing kit security doors for reinforced profil 115 x 25 mm		0.70	19.60
A600000016	Brass padlock 40 mm - steel shackle 22 mm			12.50

*Requires a fixing kit ref. F600700001

Lower access security doors - Steel range

Reference	Product designation	Landmark	Weight kg	Price €
F600500215	Half door + cap		25.00	195.00
F600500220	Door + cap		50.00	360.00

Anti intrusion add-on accessories - Galvanized steel

Reference	Product designation	Landmark	Price €
F600503001	Lateral sheet - height 3000 mm, per pair	64	268.00
F600503003	Bottom panel - height 3000 mm	65	371.00
F600503005	Perforated sheet - height 1000 mm	66	357.00

Use our online **CONFIGURATOR**



Via our website **www.fortal.fr**

Set a few clicks your access from the products below to receive directly the plan but also the description of your project along with the quote!

- Describe your environment
- Add the options you want
- Receive the plan, the description of your project as well as the estimate



Staircase

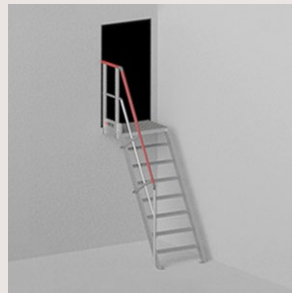

Staircase with bearing

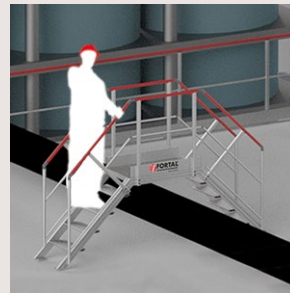

Double access staircase



Mobile platform

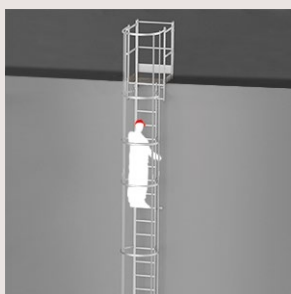

Ladder with safety cage



Scaffolding

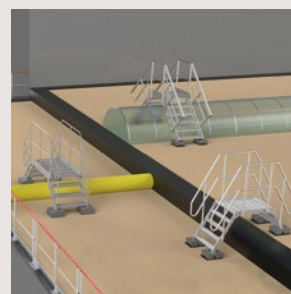

Double access platform

Excerpts from Fortal's general terms and conditions of sale

PRICES / ORDERS

Our prices may be updated at any time without prior notice. They are quoted notwithstanding circumstances which may affect prices during the order period with regard to taxes and duties on the goods, commodity prices, salaries, customs duties, transport tariffs and exchange rates.

Any upward variations or fluctuations prior to delivery remain at the customer's cost. The customer shall also benefit from any downward trend.

Unless otherwise stipulated, and upon SAS FORTAL's sole discretion, orders given orally are deemed to be firm and irrevocable. Should the customer cancel all or part of the order, the full price shall remain due. This provision neither excludes nor limits the scope of the cancellation clause hereunder.

PAYMENT TERMS

Payments shall be made net without discounts or deductions on the due date quoted on the invoices. Bills of exchange and bills for acceptance do not act as a substitution or exemption from the terms or place of payment.

When a banker's draft or negotiable instrument has been agreed to, they must be accepted and returned within eight days of receipt.

Penalties for late payment are applicable on the day following the due date quoted on the invoice, i.e. in principle, excepting stipulations to the contrary agreed between the parties, on the date the goods are received or the date of performance of the service requested.

In all events, the provisions laid down in the Act called LME (French Act on Modernising the Economy) of 4 August 2008 must be adhered to. Should the sums due be paid after the date quoted on the invoice, this late payment shall lawfully give rise to the settlement of late payment interest set at three times the legal interest rate.

In accordance with the provisions of Article L.441-6 of the French Commercial Code, enforceability is not subject to the prior sending of formal notice.

Late payments accepted by our company also automatically and rightfully incur the payment of an indemnity set at three times the legal interest rate (default interest).

In the event of late payment, we reserve the right to defer or cancel current orders without prejudice to any other recourse and to rightfully demand payment in full of all outstanding debts or debts that shall fall due, without prior notice.

PENALTY CLAUSE

Excepting deferral by our company, it is expressly agreed, whatever the means of settlement agreed on, that failure to pay at the due date shall give rise to legal action and the application of an indemnity set at 15 % of the amount outstanding as damages, to which shall be added all legal costs and legal interest.

DELIVERY DEADLINES

Our delivery deadlines are purely indicative. They do not constitute a formal commitment on our part. Any delay in delivery shall not constitute a reason for cancelling the order and shall in no way stand as a pretext for claims for compensation to the benefit of the customer.

In all events, should penalties be explicitly provided for between the parties, they shall not be due in the event of force majeure, strikes, lock-outs, damage due to incidents, late or interrupted transport, failure of suppliers towards our company or for any other event beyond our control, even if said event does not constitute force majeure under existing French law.

PACKAGING - TRANSPORT

Unless otherwise expressly stipulated, our prices are quoted for goods ex-works or ex-warehouse, packaging not included. In the case of shipment carriage-free, the goods shall travel by the most economical means. Additional costs for any other means of transport shall be exclusively payable by the customer.

The goods travel at the risk of the receiver even when shipment is carriage-free. Should damage, loss or theft occur in transit, or in the event of a late delivery, it is up to the receiver to exercise any recourse against the carriers. In all events, excepting complaints reported upon delivery, the purchaser may not enter a claim for non-conformance afterwards in order to withdraw from payment, unless a claim is sent to us within 5 days of the invoicing date by recorded delivery mail with acknowledgement of receipt.

Should the purchaser abstain from taking delivery of the goods, the payment of said goods remains payable in full without any formal notice being sent for the goods to be recovered, and without prejudice to the payment of damages.

Furthermore, SAS FORTAL insists that proof of the delivery of the goods shall necessarily entail signature of the delivery slip, since actual practice (in particular delivery to worksites) does not often allow for signature at the point of delivery.

OWNERSHIP CLAUSE

By express agreement, the goods delivered shall remain the property of SAS FORTAL until they are paid for in full, in accordance with the provisions of French Act n° N°80.335 of 12 May 1980. Should the purchaser fail to pay within the agreed term, the sale shall be rightfully rescinded. The parties agree to apply this clause, it being understood that this provision does not hinder the full transfer of risks.

CANCELLATION CLAUSE

Should the customer fail to perform any one of their commitments, including in the event of non-payment on the due date of all or part of the amounts due, the contract shall be rightfully cancelled at SAS FORTAL's convenience, 15 days after sending formal notice addressed to the customer requesting that they put an end to the non-respect of their commitments, should such request be in vain, without it being necessary to enter a suit before the courts and notwithstanding the performance of all contractual obligations on the part of the customer.

Cancellation shall only come into effect once a recorded delivery letter with acknowledgement of receipt has been sent to the customer informing them of the cancellation in due form. As soon as this letter has been sent, SAS FORTAL shall be released from all obligations and all liability towards the customer.

In the event of cancellation, the purchaser shall owe a flat-rate contractual indemnity amounting to 15 % of the price quoted on the invoice(s). This indemnity may be offset against any sum owed by SAS FORTAL.

WARRANTY

FORTAL products benefit from a 2-year warranty from the delivery date. Supply of spare parts equivalent to the original part is guaranteed for 10 years.

CONFIDENTIALITY

The parties undertake not to communicate any information received during the performance of the service in any form whatsoever.

LAW APPLICABLE

The validity, interpretation and performance of this Contract and the resolution of any disputes related thereto shall be executed and interpreted with reference to French law.

JURISDICTION

The Parties shall make every effort to find a friendly settlement to any disagreement resulting from the interpretation or the performance of the agreement herein.

Should the Parties fail to find a settlement and should the disagreement persist, they agree forthwith to refer the matter to the court which has jurisdiction over the head office of SAS FORTAL, even in the case of multiple defendants or the introduction of third parties.

Design and manufacture of secure access for work at height



Ask for our
general catalog

Dealer's stamp



FORTAL[®]
www.fortal.fr

🇫🇷 Made in France

Z.I. du MUCKENTAL - F-67140 BARR

☎: +(33) 03 88 58 53 53

✉: +(33) 03 88 58 53 54

✉: info@ortal.fr



web